



## Seneca Twin over Full Bunk Bed

5162: SE-TF-BB-CO

5171: SE-TF-BB-NB

5166: SE-TF-BB-WH

Congratulations on the purchase of your Seneca Twin over Full bunk bed. This bed has been crafted to the highest standards of quality and safety and will give you many years of enjoyment and practical use.

Since this bed is a natural wood product there will be variations in color and grain, and minor wood grain checking may occur. This is normal and does not compromise the integrity and beauty of your bed. Variation in the character of solid hardwood is integral to the beauty and appeal of hardwood furniture, and distinguishes it from lower quality materials.

Several Basic safety considerations must be adhered to when using this bunk bed.

### TO HELP PREVENT SERIOUS OR FATAL INJURY FROM ENTRAPMENT OR FALLS:

- Never allow a child under 6 years on upper bunk
- Always use the recommended size mattress or mattress support (Standard twin 38" x 74" (96.5cm x 188cm), on upper bed and standard full 54" x 74" (137.2 cm x 188 cm) on lower bed, to help reduce the risk of entrapment or falls
- Ensure thickness of mattress does not exceed 9 inches (22.9cm)
- Mattress must be at least 5 inches (12.7cm) below upper edge of guardrails
- Always use guardrails on both sides of upper bunk
- Do not allow horseplay on or under bed(s) and prohibit jumping on the bed
- Prohibit more than one person on the upper bunk
- Always use the ladder for entering and leaving upper bunk
- If the bunk will be placed next to a wall, the guardrail that runs the full length of the bed should be placed directly against the wall to prevent entrapment between the bed and the wall
- Follow the information on the warning labels appearing on the upper bunk and structure and on the carton
- Do not remove warning label from bed
- Periodically check and ensure that the guardrail, ladder and other components are in their proper position, free from damage and that all connectors are tight
- Do not use substitute parts. Contact manufacturer or dealer for replacement parts
- The use of water or sleep flotation mattress is prohibited
- Keep these instructions for future reference
- Use of a night light may provide added safety for a child using the upper bunk
- STRANGULATION HAZARD- Never attach or hang items to any parts of the bunk bed that are not designed for use with the bed; for example, but not limited to, hooks, belts or jump ropes

On this insert you will find a list of the hardware and bunk bed parts necessary for assembly, as well as detailed instructions. Assembly is quite simple and requires only a flat head screwdriver and a Phillips head screwdriver. The use of a power drill with Phillips head attachment is helpful but not necessary. Assembly will be most easily accomplished if you take the time to carefully sort the hardware and familiarize yourself with the function of each piece.

If you should require assistance with assembly, part replacement or any other matter, contact the toll-free Epoch Design Service Center from anywhere in the Continental United States, Monday through Friday, 9 AM – 5 PM Pacific Standard Time at 1-800-589-7990. You may also email your requests or comments to [info@epochbydesign.com](mailto:info@epochbydesign.com) and a service representative will respond.

Thank you and Enjoy

**HAVE QUESTIONS OR CONCERNS? CALL US FIRST: 1-800-589-7990**

Copyright © 2018 Epoch Design™ All rights reserved

# HARDWARE LIST

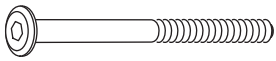

16x **100 mm bolts**  
Used to connect headboards and footboard to side rails

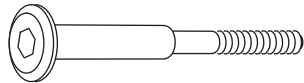

2x **80 mm bolts**  
Used to secure center support

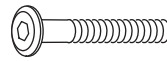

16x **45 mm bolts**  
Used to assemble long safety rails and connect safety rails to side rails

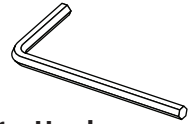

1x **Hex key**  
Used to tighten hardware



18x **Barrel nuts**  
Used to secure bolts

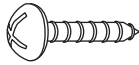

2x **15 mm round head screws**  
Used to attach ladder hooks to side rails

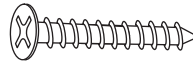

75x **30 mm Slat screws**  
Used to secure slats to side rails and center supports



4x **Bunk connector pins**  
Used to connect upper bunk to lower bunk

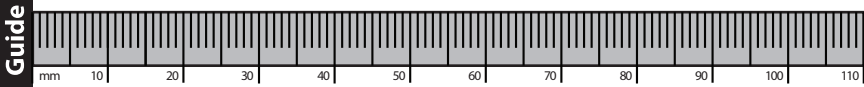

# BUNK BED PARTS

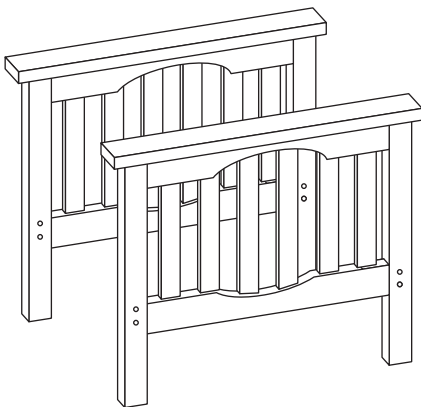

2x **Upper end boards**  
Used on upper bunk

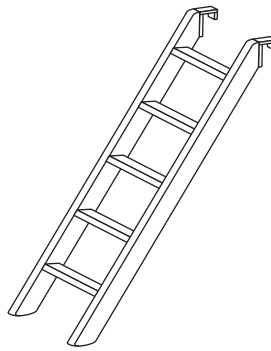

1x **Ladder**  
Attaches to upper side rail for entry to upper bunk

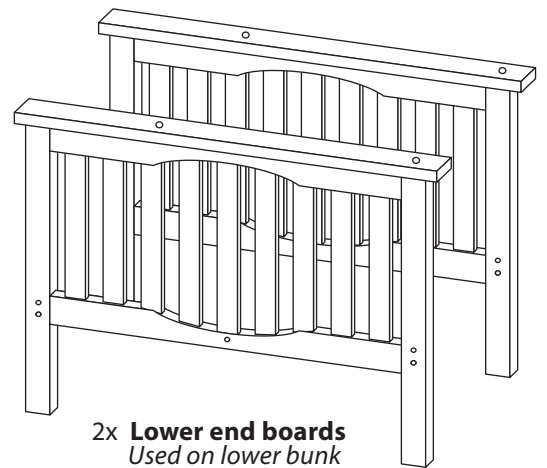

2x **Lower end boards**  
Used on lower bunk

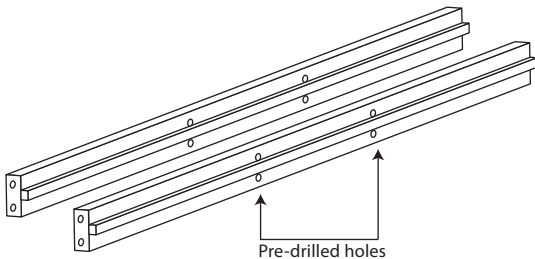

2x **Upper side rails**  
Used to connect upper end boards

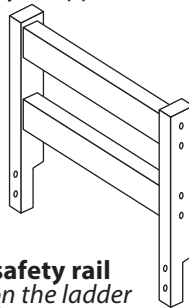

1x **Short safety rail**  
Used on the ladder side of the upper bunk

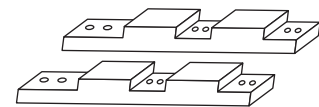

2x **Upright supports**  
Used to attach long safety rails to upper side rails

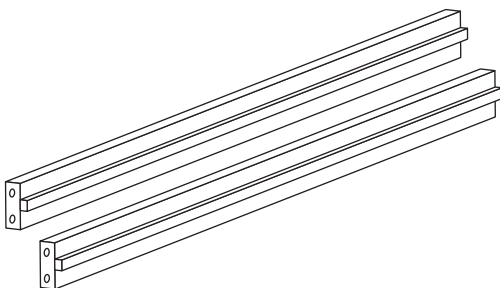

2x **Lower side rails**  
Used to connect lower end boards

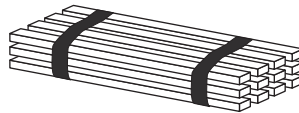

1x **Twin slat bundle**  
Rest evenly strap side down on upper bunk side rails

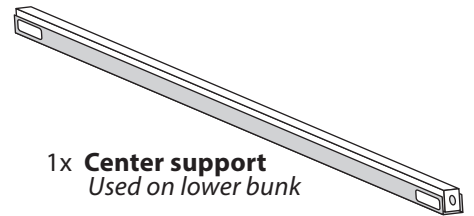

1x **Center support**  
Used on lower bunk



1x **Full slat bundle**  
Rest evenly strap side down on lower bunk side rails

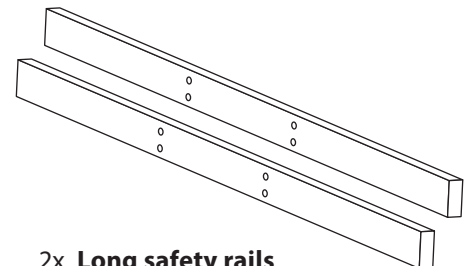

2x **Long safety rails**  
Used for attachment to upright supports on wall side of bunk

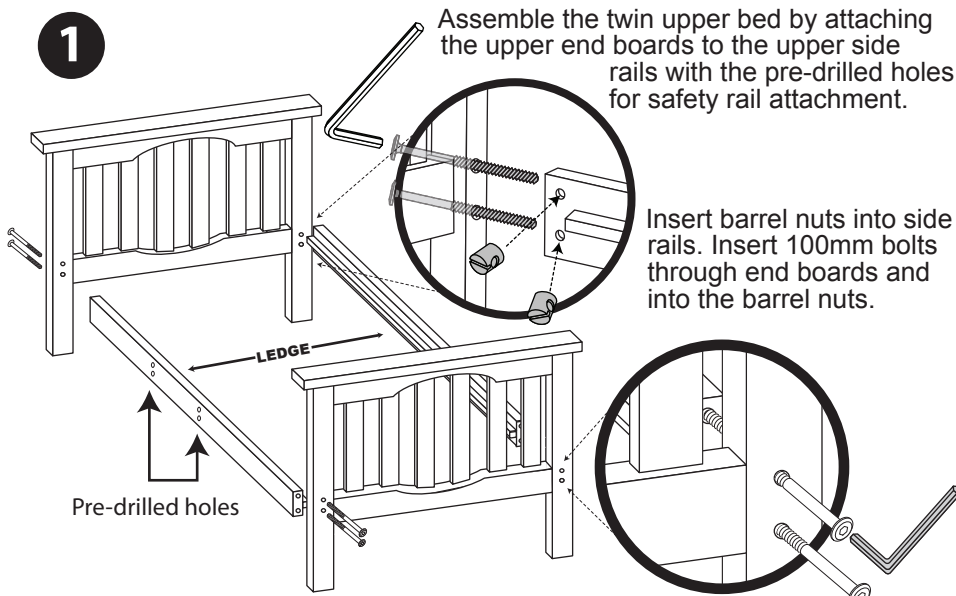

Tighten 100mm bolts with the 5mm Allen Wrench provided.

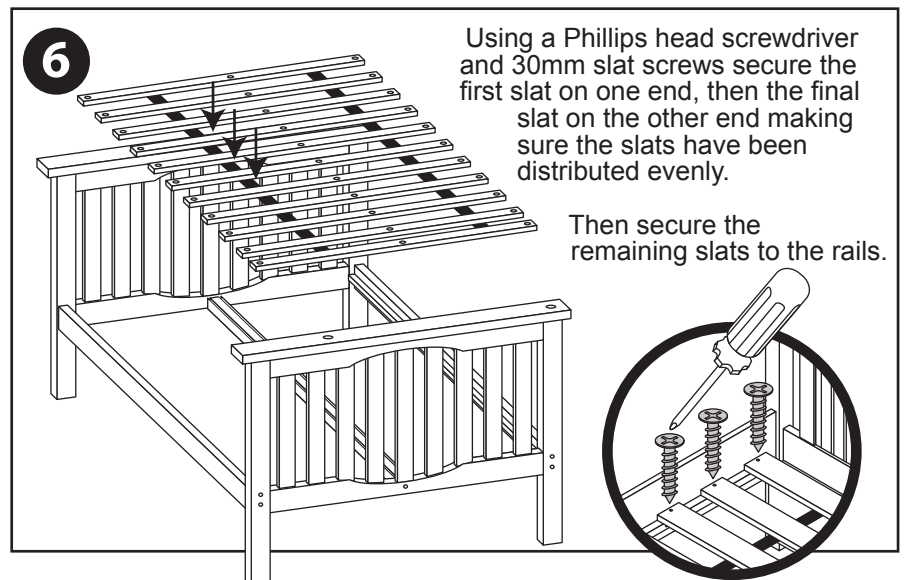
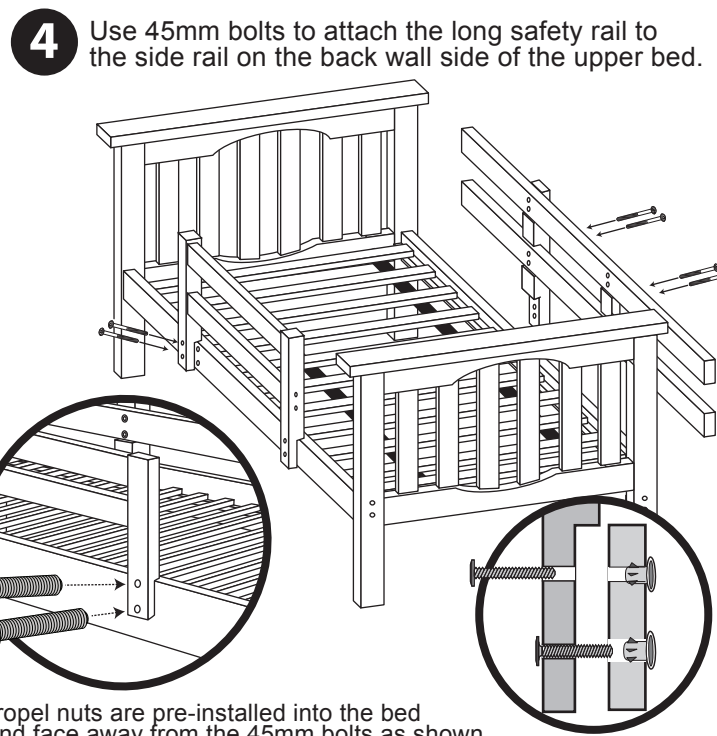
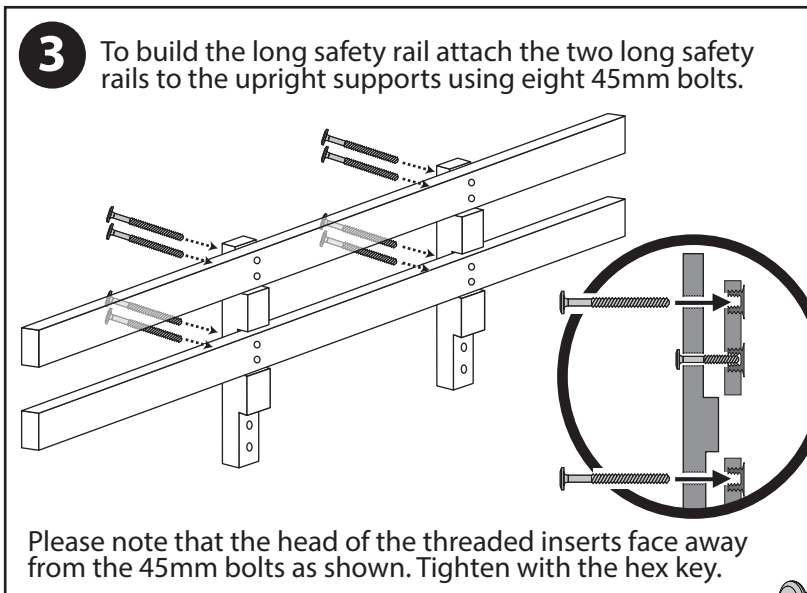
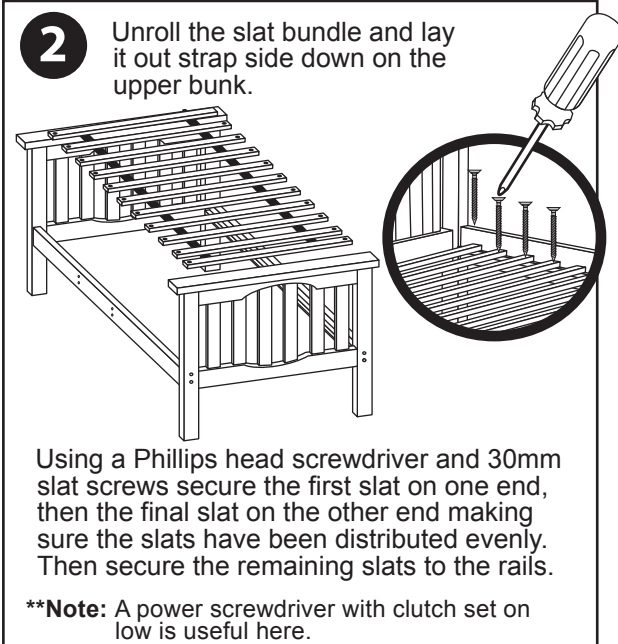

7

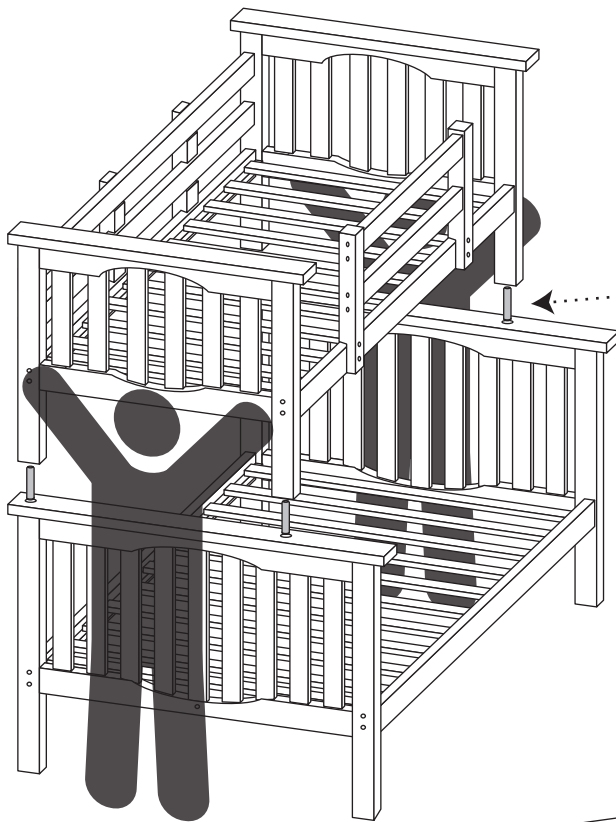

Insert a bunk connector pin into each of the four holes on the bottom end boards.

Then with assistance place the upper bunk on top of the lower bunk.

8

Attach ladder to side rail of upper bunk. Now use the hex key to retighten all bolts so that bunk bed assembly is rigid.

Be sure to periodically tighten hardware as it may loosen with usage and changing humidity.

If desired, you may permanently affix the ladder to either side of the short safety rail by using two 15mm round head screws.

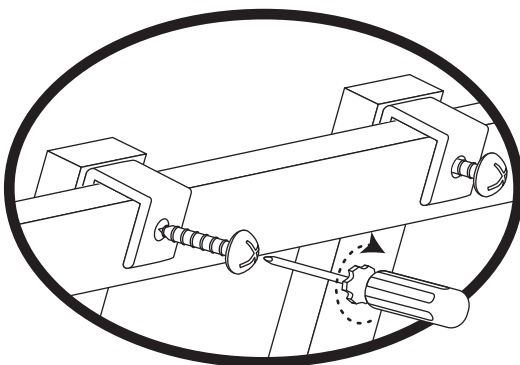
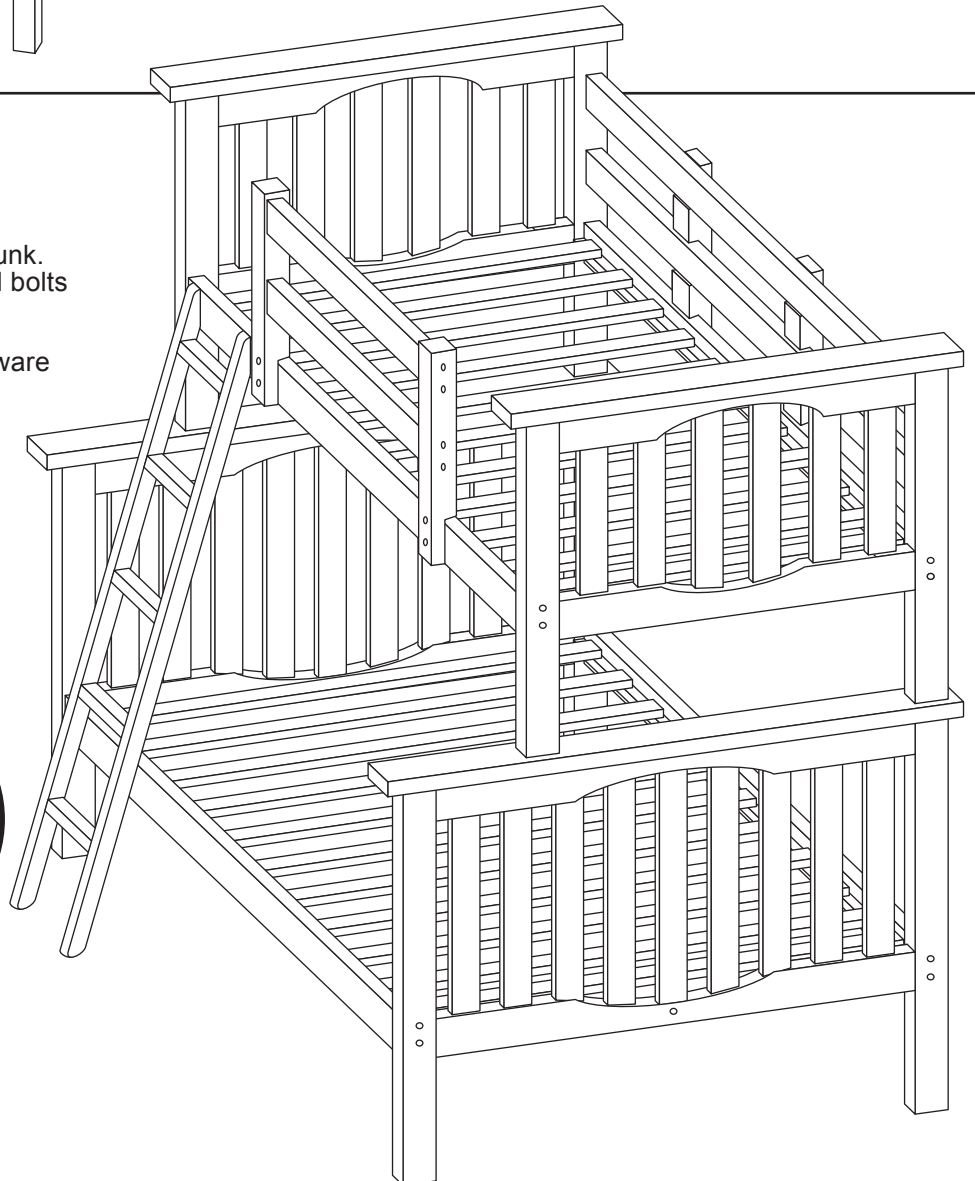

**\*\*NOTE:** Do not affix ladder if you have purchased under bunk drawer.